

KFZ-Glühlampen Sockelübersicht

Hier finden Sie eine Sockelübersicht der gebräuchlichsten KFZ-Lampen!

(z.B. Halogen, Glassockel, Kunststoffsockel, Soffitten, Xenon und andere Lampentypen)

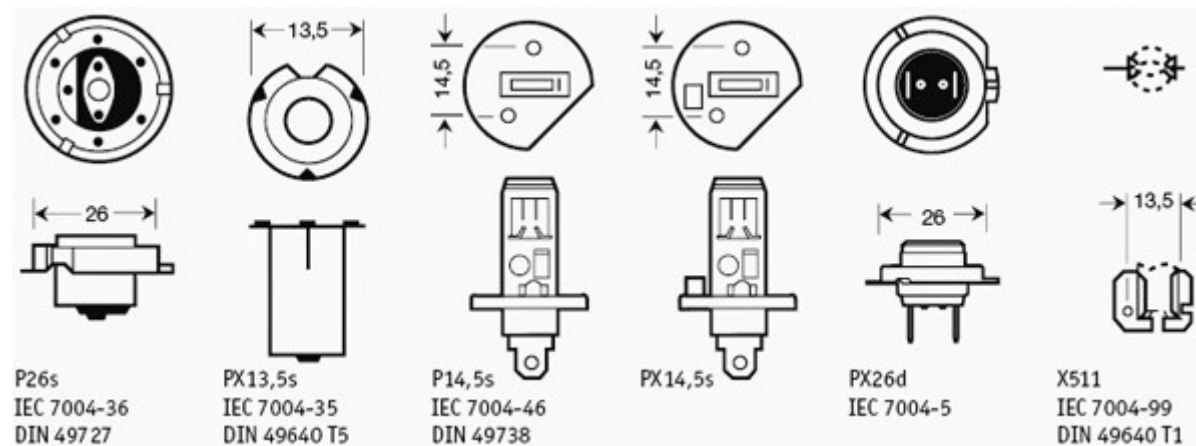

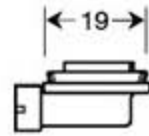

PGJ19
PGJ19-1
PGJ19-2
PGJ19-5
IEC 7004-110

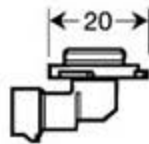

P20d
IEC 7004-31

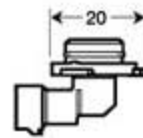

PZ20d
IEC 7004-31

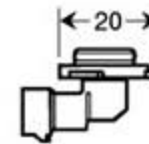

PY20d
IEC 7004-31

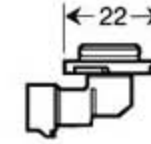

P22d
IEC 7004-32

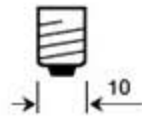

E10
IEC 7004-22
DIN 49610

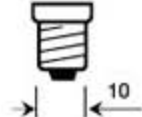

EP10
IEC 7004-30
DIN 49701

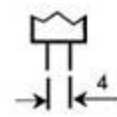

G4
IEC 7004-72
DIN 49757

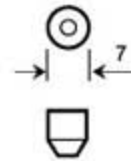

SV7-8
IEC 7004-80
DIN 49705 T1

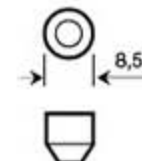

SV8,5-8
IEC 7004-81
DIN 49705 T2

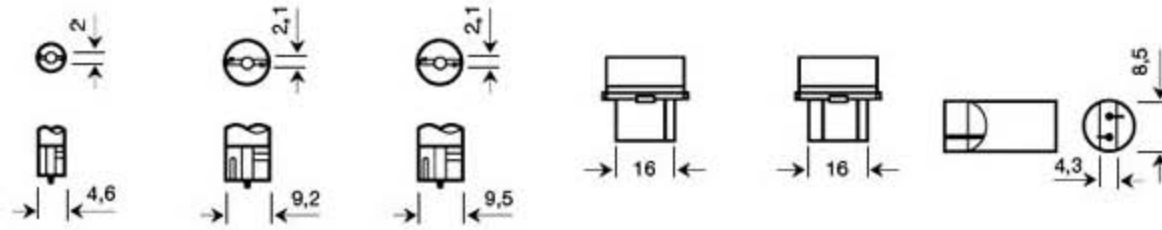

W2x4,6d
IEC 7004-94
DIN 49632 T1

W2,1x9,2d

W2,1x9,5d
IEC 7004-91
DIN 49632 T2

W2,5x16d

W2,5x16q

W4,3x8,5

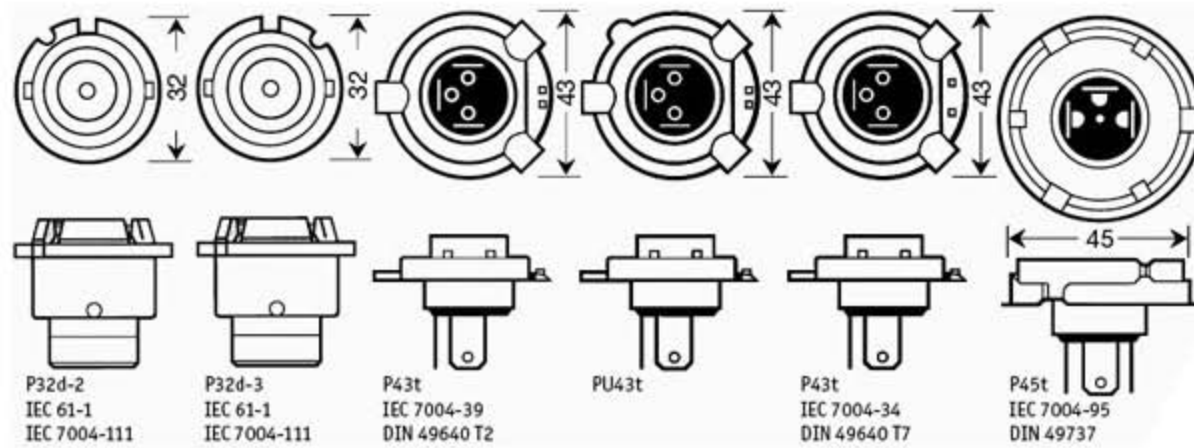

P32d-2
IEC 61-1
IEC 7004-111

P32d-3
IEC 61-1
IEC 7004-111

P43t
IEC 7004-39
DIN 49640 T2

PU43t

P43t
IEC 7004-34
DIN 49640 T7

P45t
IEC 7004-95
DIN 49737

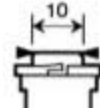
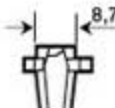
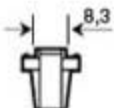
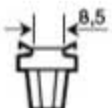
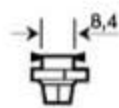
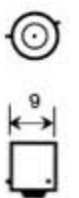
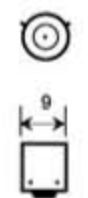
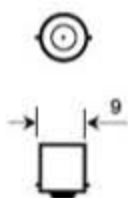
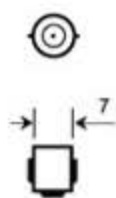
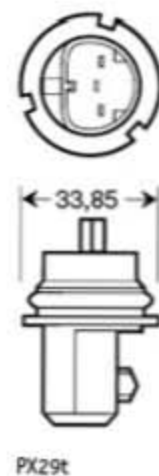
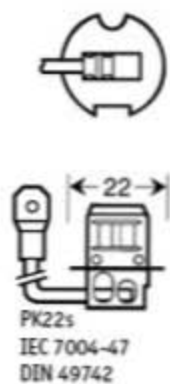

BA7s
IEC 7004-15
DIN 49710

BA9s
IEC 7004-14
DIN 49715

BAY9s
IEC 7004-9
DIN 49640

BAX9s
IEC 7004-8
DIN 49640

B8,4-12,5
BX8,4-12,5

B8,5d
BX8,5d

B8,3d

B8,7d

B10d-14,5
BX10d-14,5

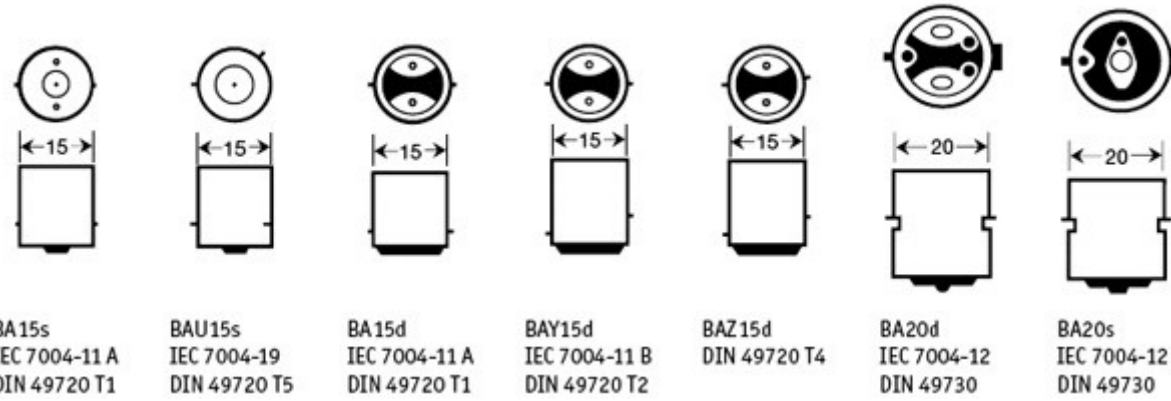

- B8,5d
- B10d
- BA9s DIN 49715 IEC 7004-14

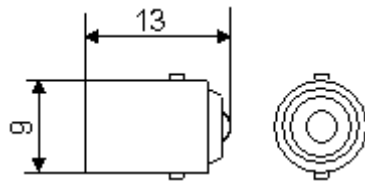

- BAX9s DIN 49640 IEC 7004-14

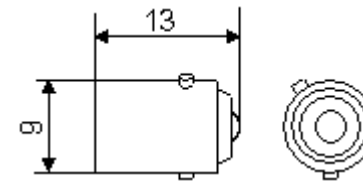

- BX8,4d
- BA15s DIN 49720 IEC 7004-11A9

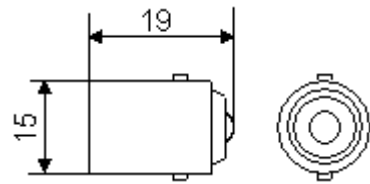

- BAU15s DIN 49720T5 IEC 7004-19-1

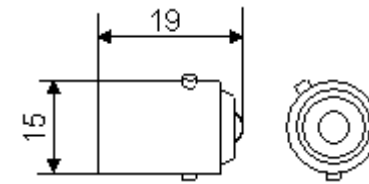

- BAY15d DIN 49720T2 IEC 7004-11B

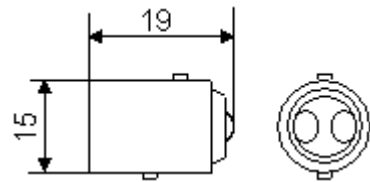

- BAZ15d IEC 7004-11C

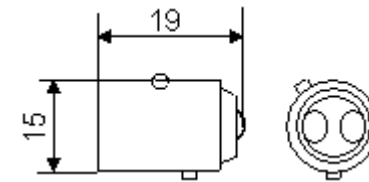

- BA20s DIN 49730 IEC 7004-12

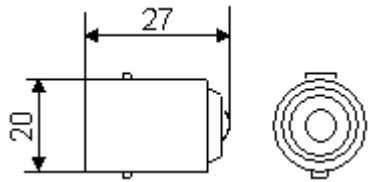

- BA20d DIN 49730 IEC 7004-12

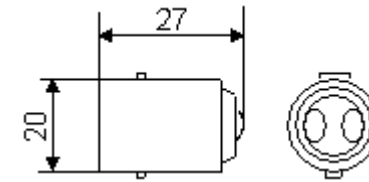

- P14,5s DIN 49738 IEC 7004-46 (H1)

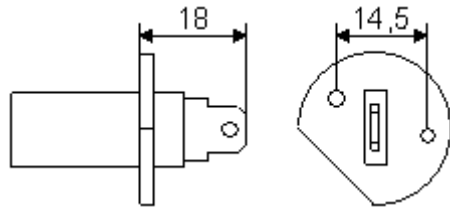

- P20d
- P22d
- P26s
- P29t
- P32t
- P43t
- P45t DIN 49737 IEC 7004-95 (R2)

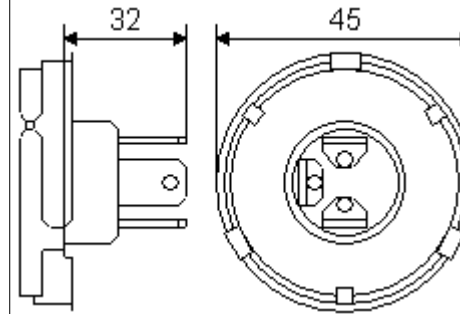

- PGJ19
- PK22s
- PK32d
- PK32d
- PKY22s
- PX26d
- PX29t
- PY20d

- SV7-8
- SV8,5-8
- W2x4,6d
- W2,1x9,5d
- W2,5x16d
- W3x16d
- X511

